

NEW

ProSecure™ Pace Security Door Hinge

Thinking about the fabricator every step of the way.



Strong, Secure and even Faster.



Hardware that starts with **you**.



NEW

ProSecure™ Pace Security Door Hinge.

With sub-40 second fitting times achieved under test conditions, the ProSecure Pace Security hinge has been designed to speed up door fabrication without compromising on quality and aesthetics.

An innovative frame datum allows consistent repeatability and precise fabrication on the factory floor. Making no contact with the profile, the hinge slides directly onto the frame datum - eliminating any risk of damaging the profile.

The auto-locking hinge cover prevents access to the fixing screws and locks the steel hinge pin in place. For onsite adjustment, handing LH or RH, or to remove the pin for fitting in tight reveals, a concealed push button simply releases the cover.



Independently tested.

Tested to PAS 24:2022 for enhanced security, endures extreme corrosion resistance tested to BS EN 1670 Grade 4 for plated and Grade 5 for painted finishes, 200,000 cycles under load, and supports heavy-duty doors up to 100kg. Approved by Secured by Design.



14 colour options.



White



Black



Smokey
Chrome



Smooth Satin

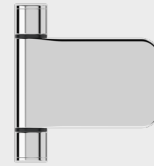

Chrome

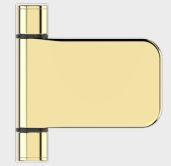

Gold



Heritage
Black



Anthracite
Grey



Agate Grey

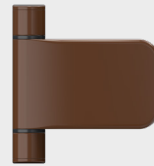

Light Oak

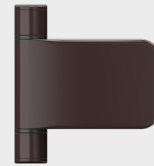

Brown



Irish Oak



Chartwell
Green



Cream

Fit it fast...

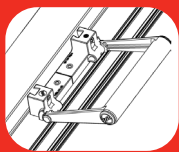

Jig the frame

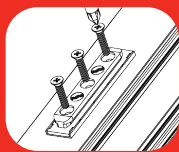

Fix the datum

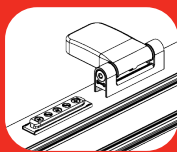

Slide on the
hinge

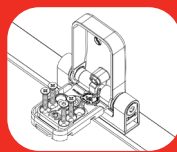

Fix the sash
part

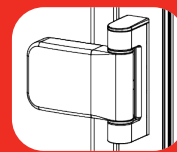

Close the lid

Strong, Secure and even Faster.

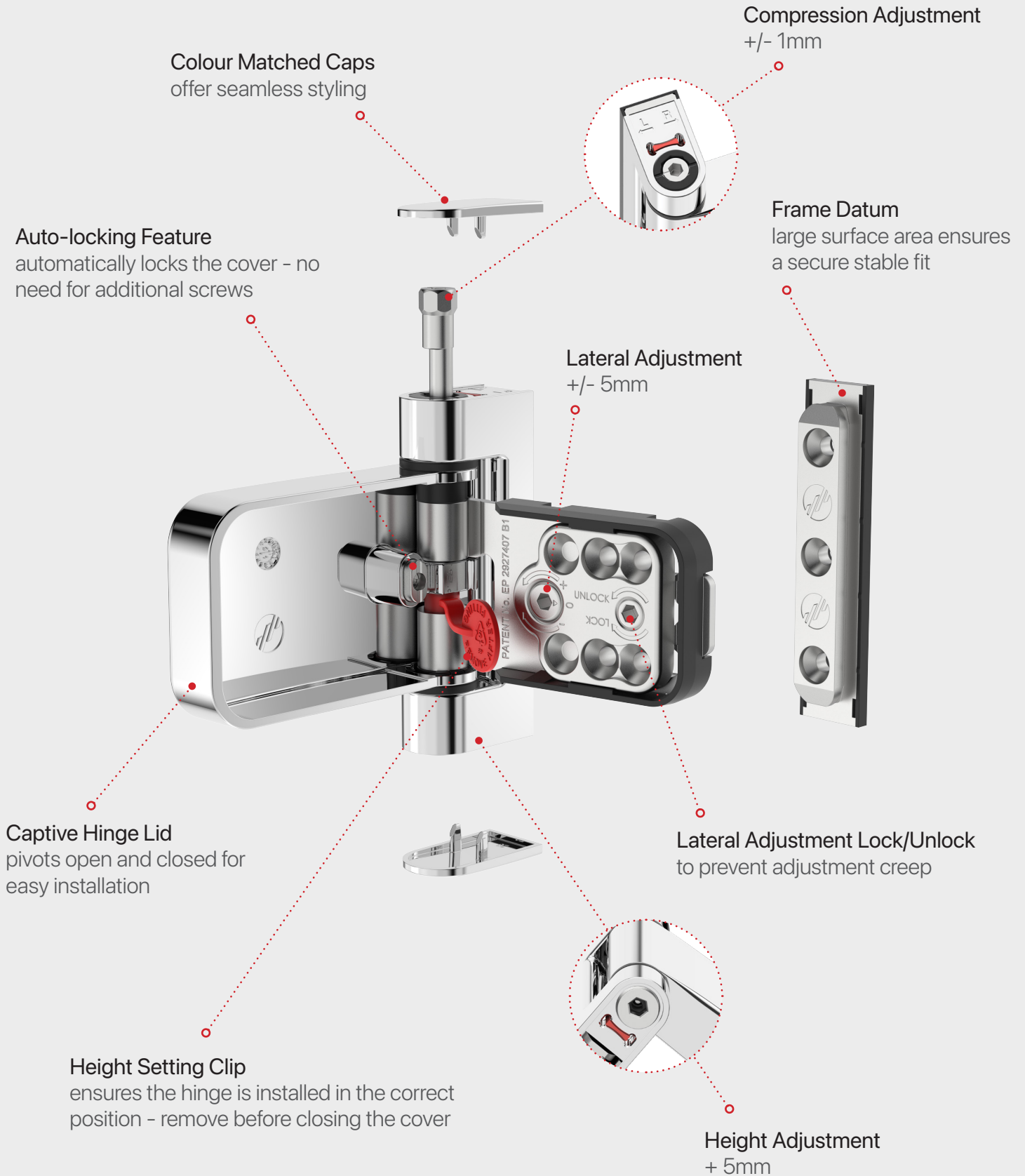

Dimensional Drawings.

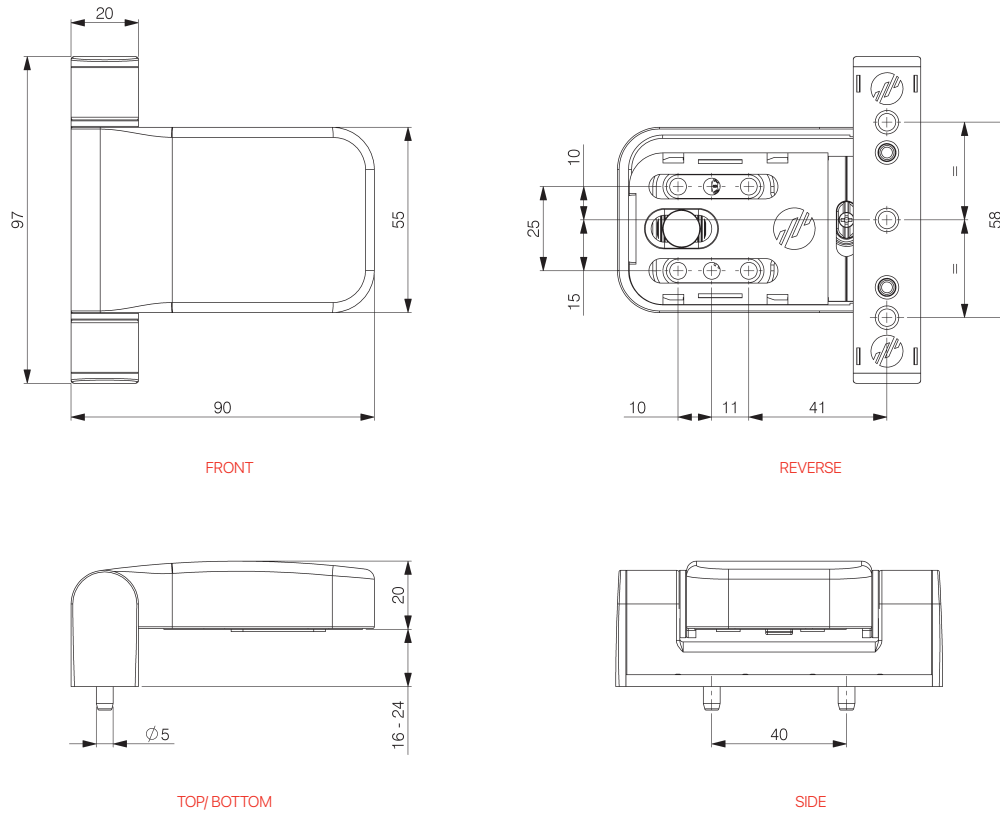

Suitable Profiles.

Aluplast Ideal 70	19mm
Deceuninck 2500	20mm
Deceuninck 2800	21-22mm
Deceuninck 5000	20mm
Deceuninck 3000	20mm
Profile 22 Optima	21mm
Eurocell Logik 70	21mm
Eurocell Modus	19mm
Kommerling C70	21mm
Kommerling O70	21mm
Linlar 70mm	21mm
Linlar Zero 90	21mm
REHAU Calibre	20mm
REHAU Total 70	19mm
Selecta Advance 70	19mm
Swish 24/7	21mm
VEKA M70	19mm
VEKA FS	21mm
Spectus Elite 70	21mm

Part Numbers.

ProSecure Pace	19mm RH	19mm LH	20mm RH	20mm LH	21 mm RH	21mm LH
White	020060R	020060L	020080R	020080L	020100R	020100L
Black	020065R	020065L	020085R	020085L	020105R	020105L
Smokey Chrome	020067R	020067L	020087R	020087L	020107R	020107L
Smooth Satin	020079R	020079L	020099R	020099L	020119R	020119L
Polished Chrome	020064R	020064L	020084R	020084L	020104R	020104L
Gold PVD	020062R	020062L	020082R	020082L	020102R	020102L
Anthracite Grey	020069R	020069L	020089R	020089L	020109R	020109L
Brown	020061R	020061L	020081R	020081L	020101R	020101L
Irish Oak	020075R	020075L	020095R	020095L	020115R	020115L
Light Oak	020063R	020063L	020083R	020083L	020103R	020103L
Chartwell Green	020068R	020068L	020088R	020088L	020108R	020108L
Cream	020072R	020072L	020092R	020092L	020112R	020112L
Heritage Black	020074R	020074L	020094R	020094L	020114R	020114L
Agate Grey	020076R	020076L	020096R	020096L	020116R	020116L

Jig	026903
-----	--------

Supplied in box quantities of 12.
If you require an alternative profile related option, please contact the Mila sales office on 01327 312 400.

Scan me.

To see more online at mila.co.uk & get a fast quote

